

Varenummer: 206153M12KS

Beskrivelse: E+G fjedrende trykstykke 615.3-M12-KS

Mål

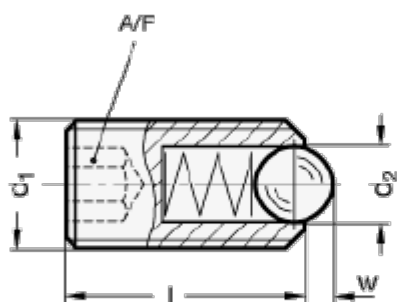

Thread locking **PFB**
Polyamide patch
for type **K**



Thread locking **PFB**
Polyamide patch
for type **KS**



Thread locking **MVK**
Micro encapsulation precoat
(for all types)

A/F	= 6
d1	= M12
d2	= 8
Fjedre styrke i N	= 61
l	= 26
Max fjeder belastning i N	= 110
w	= 2.5